



Viss Veikaliem un Noliktavām



INTEGRĒTĀ
PLAUKTU SISTĒMA
55x40

01 INTEGRĒTĀ PLAUKTU SISTĒMA

IPS 55x40 - Pamata izmēri



Plauktu sistēma IPS 55x40 ir tipveida plauktu konstrukcijas, kuru pamatā ir rāmis, kas sastāv no statnēm, kuru izmēri taisnstūra šķērsgrīzumā ir 55x40 mm.

Rāmji ir svarīgākie elementi plauktu nestspējas struktūrā.

Plauktu sistēmas IPS 55x40 konstruktīvie pamata izmēri uzrādīti zīmējumos.

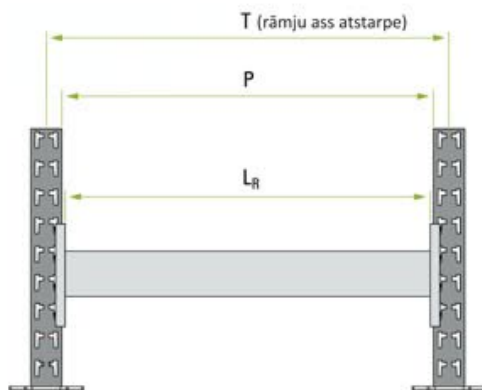
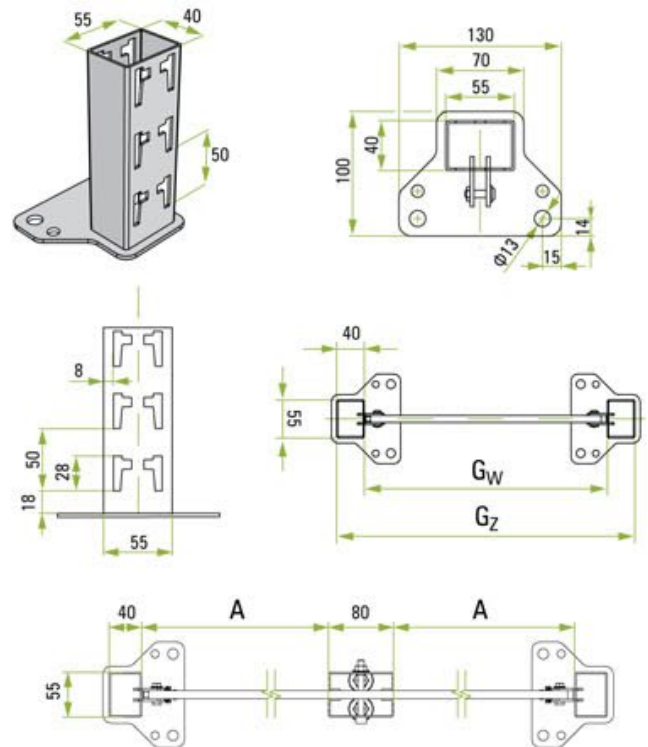

Sija [Lh]	T [mm]	P [mm]	Lr [mm]	Integrācija Lh plaukti
1250	1275	1220	1209	1250
1330	1358	1303	1292	1330
2000	2025	1970	1959	2×1000
2500	2525	2470	2459	2×1250
2660	2691	2636	2625	2×1330
2730	2761	2706	2695	-
3000	3025	2970	2959	3×1000

Rāmis [Gh]	Gz [mm]	Gw [mm]	A [mm]	Integrācija Gh plaukti
600	567	487	-	470
700	667	587	-	570
800	767	687	-	670
950	934	854	387	370+370
1150	1134	1054	487	470+470
1350	1334	1254	587	570+570
1550	1534	1454	687	670+670

Diagonāļu stiprinājumu izvietojuma shēma rāmjiem, kas būvēti uz statnēm 55 x 40 mm



G-600



G-700



G-800



G-950



G-1150



G-1350



G-1550

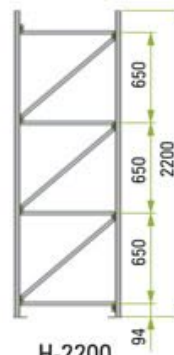

H-2200

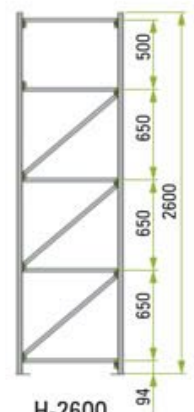

H-2600

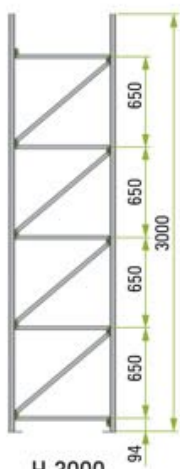

H-3000

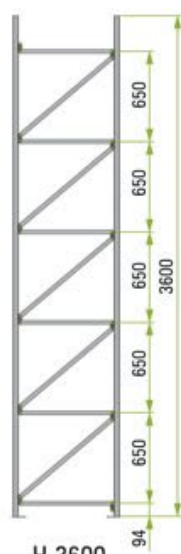

H-3600

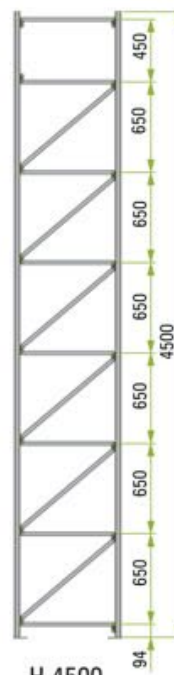

H-4500

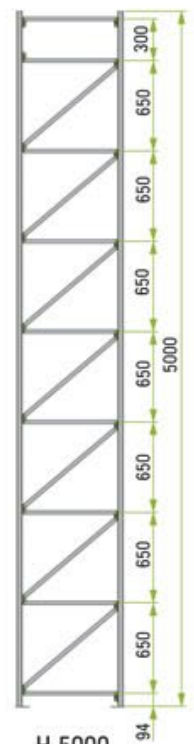

H-5000

03 IPS 55x40

Konstrukcijas nestspēja. Rāmji ar statnēm 55 x40 mm

Pieļaujamā slodze plauktiem, kas būvēti uz 55 x 40 mm profila rāmjiem, atkarībā no vertikālā attāluma starp nākamajiem balsta šķērskociem (uzglabāšanas līmeņiem).

Informācija, kas uzrādīta tabulā nr.1 attiecināma uz plauktiem, kas būvēti no vismaz četriem segmentiem (pieciem rāmjiem).

Ja nepieciešams noteikt pieļaujamo slodzi plauktiem ar mazāku segmentu skaitu, nepieciešams izmantot atbilstošus samazinošos koeficientus:

plauktam, kas salikts no trīs segmentiem (būvēts uz četriem rāmjiem) - 0,9

plauktam, kas salikts no diviem segmentiem (būvēts uz trīs rāmjiem) - 0,8

plauktam, kas salikts no viena segmenta (būvēts uz diviem rāmjiem) - 0,7

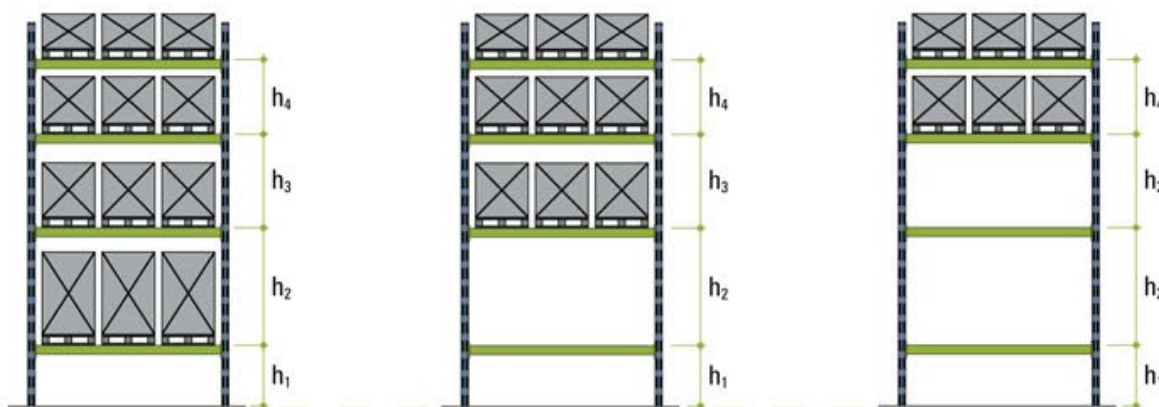

Tabula nr.1. Pieļaujamā slodze paletes tipa plauktam virs ligzdas augstumā (h)

55x40	h (h1, h2, h3, ...)- attālums starp nākamajām sijām (uzglabāšanas līmeņiem)					
	750	1000	1250	1500	1750	2000
	4800	3800	3000	2200	2000	1900

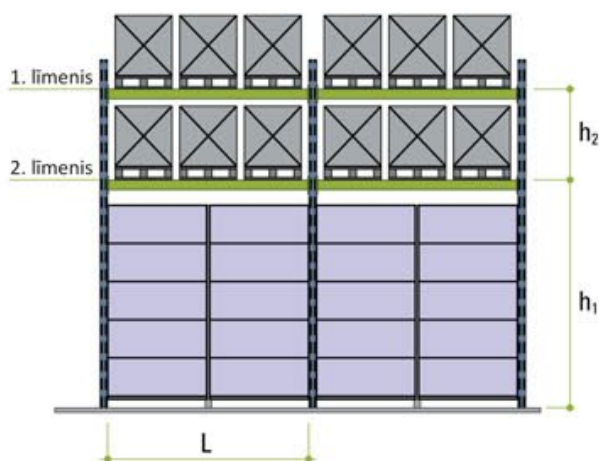

Tabula nr.2. Pieļaujamā slodze integrētai plauktam sistēmai

Integrācijas augstums h1 [mm]	h2- attālums starp nākamajām sijām (uzglabāšanas līmeņiem) Daļā virs (!) integrācijas				
	750	1000	1250	1500	1600
2200			1400		
2400			1150		
2600			950		

IPS 55x40 04

01.01

Rāmji vienpusējai integrācijai

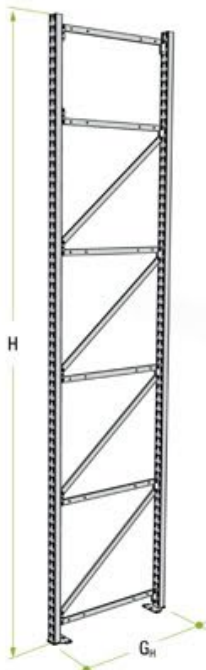

UZMANĪBU:

Integrācijai ar dziļuma samazināšanu nepieciešama adaptera izmantošana [01.03.] vai [01.04.]

Rāmji G-600

Gh	H	Kods	Integrācija Gh plaukti
	2200	IPS55401006220	
	2600	IPS55401006260	
	3000	IPS55401006300	
600	3600	IPS55401006360	470
	4500	IPS55401006450	
	5000	IPS55401006500	
	6000	IPS55401006600	

Rāmji G-700

Gh	H	Kods	Integrācija Gh plaukti
	2200	IPS55401007220	
	2600	IPS55401007260	
	3000	IPS55401007300	470
700	3600	IPS55401007360	570
	4500	IPS55401007450	
	5000	IPS55401007500	
	6000	IPS55401007600	

01.02 Līmeņa paliknis



b [mm]

Kods

1	IPS55401022
2	IPS55401023
6	IPS55401024

Rāmji G-800

Gh	H	Kods	Integrācija Gh plaukti
	2200	IPS55401008220	
	2600	IPS55401008260	
	3000	IPS55401008300	470
800	3600	IPS55401008360	570
	4500	IPS55401008450	670
	5000	IPS55401008500	
	6000	IPS55401008600	

Adaptori vienpusējai integrācijai

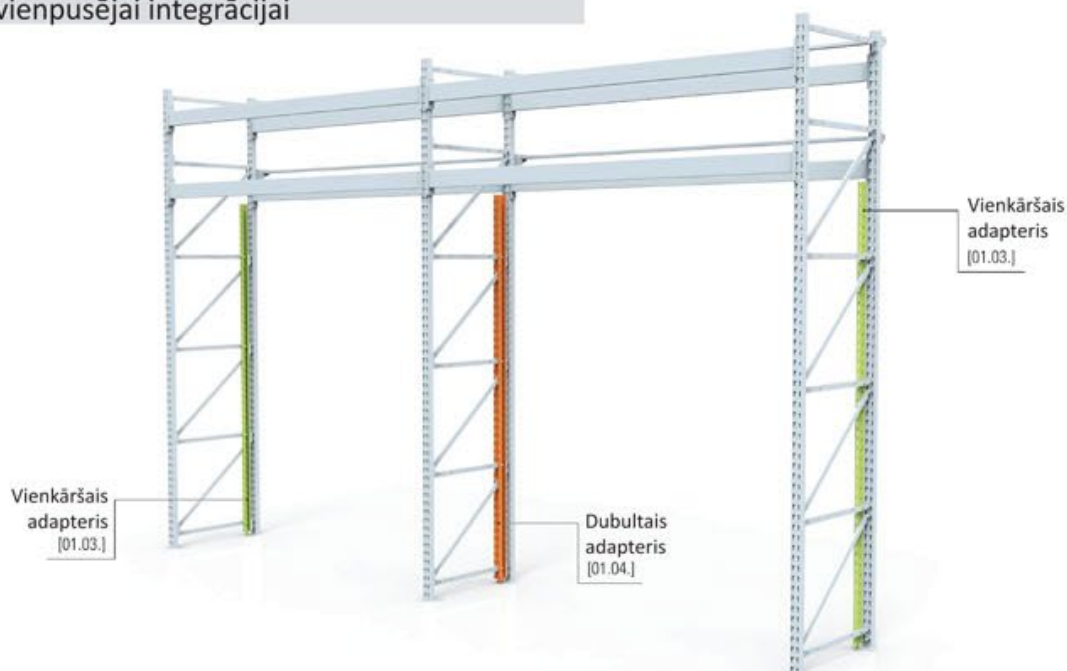

Vienkāršais adaptoris [01.03.]

Vienkāršais adaptoris [01.03.]

Dubultais adaptoris [01.04.]

05 IPS 55x40

01.03 Vienkāršais adapteris vienasējai integrācijai

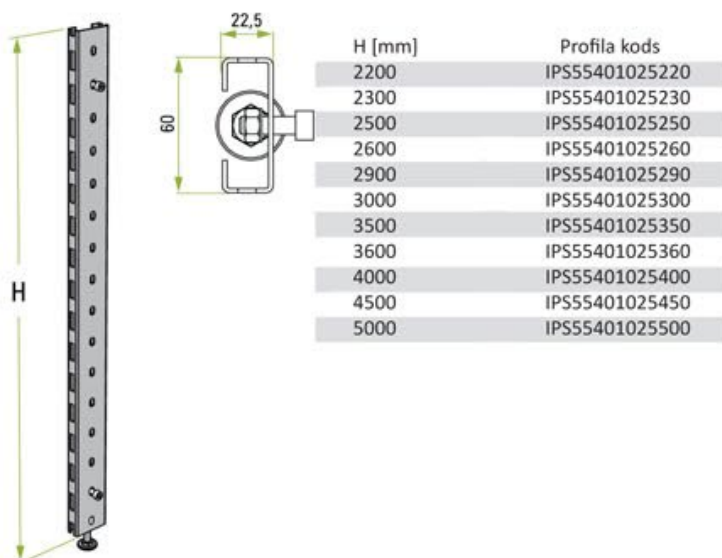

01.04 Dubultais adapteris vienasējai integrācijai

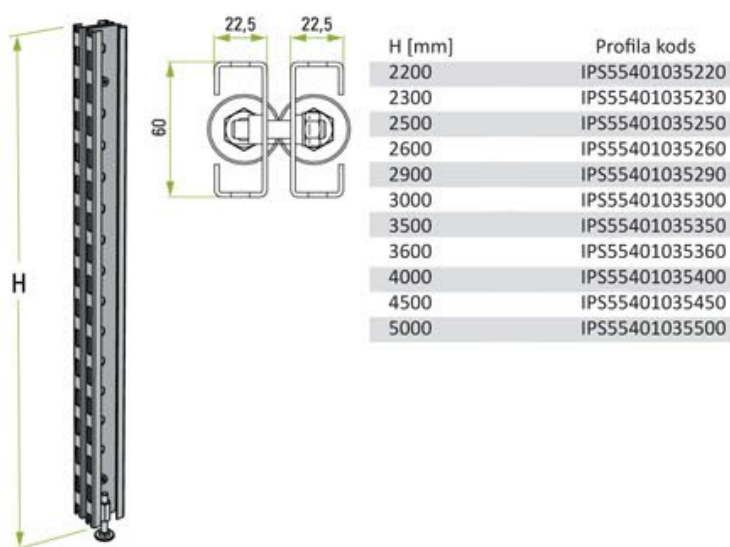

01.05 Rāmji abpusējai integrācijai

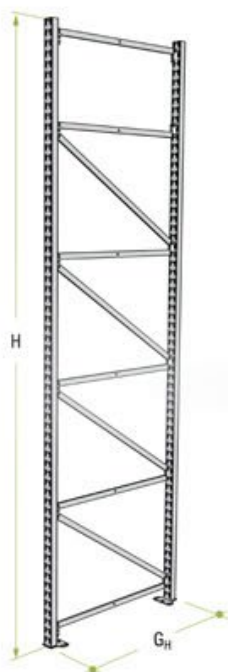

UZMANĪBU:
Integrācijas izveidei nepieciešama adaptera izmantošana [01.06.] vai [01.07.]

Gh	H	Kods	Integrācija Gh plaukti
	2200	IPSS5401045220	
	2600	IPSS5401045260	
	3000	IPSS5401045300	
950	3600	IPSS5401045360	2x370
	4500	IPSS5401045450	
	5000	IPSS5401045500	
	6000	IPSS5401045600	

Gh	H	Kods	Integrācija Gh plaukti
	2200	IPSS5401055220	
	2600	IPSS5401055260	
	3000	IPSS5401055300	
1150	3600	IPSS5401055360	2x470
	4500	IPSS5401055450	
	5000	IPSS5401055500	
	6000	IPSS5401055600	

Gh	H	Kods	Integrācija Gh plaukti
	2200	IPSS5401065220	
	2600	IPSS5401065260	
	3000	IPSS5401065300	
1350	3600	IPSS5401065360	2x570
	4500	IPSS5401065450	
	5000	IPSS5401065500	
	6000	IPSS5401065600	

Gh	H	Kods	Integrācija Gh plaukti
	2200	IPSS5401070220	
	2600	IPSS5401070260	
	3000	IPSS5401070300	
1550	3600	IPSS5401070360	2x670
	4500	IPSS5401070450	
	5000	IPSS5401070500	
	6000	IPSS5401070600	

IPS 55x40 06

Adaptēri abpusējai integrācijai

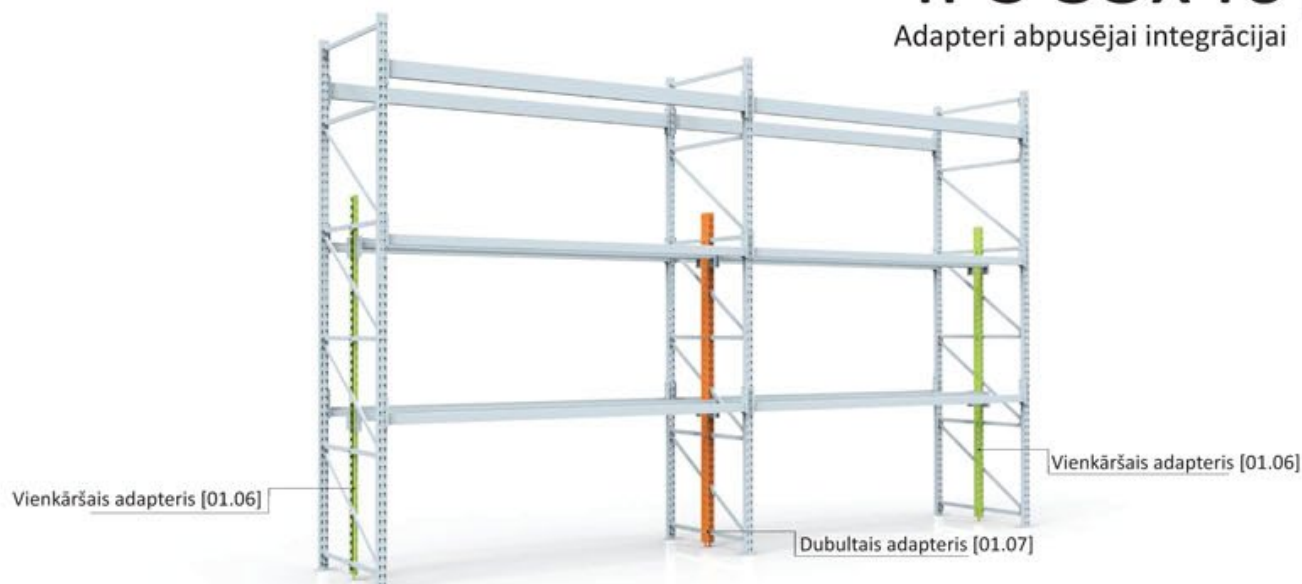

01.06 Vienkāršais adapteris abpusējai integrācijai

01.07 Dubultais adapteris abpusējai integrācijai

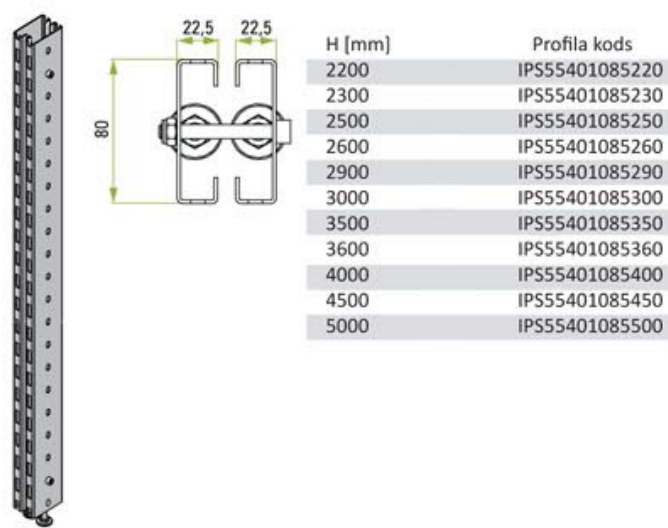
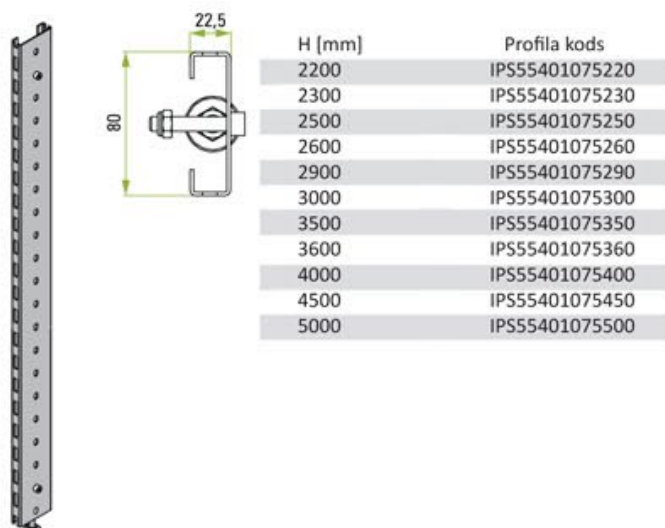

01.08 Gala rāmji divpusējai integrācijai

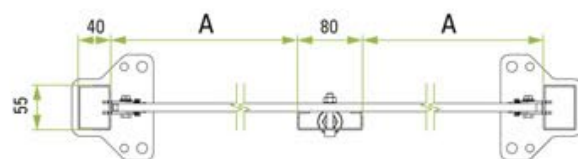

Gh	A	H	Kods	Integrācija Gh plaukti
		2200	IPSS5401095220	
		2600	IPSS5401095260	
		3000	IPSS5401095300	
950	387	3600	IPSS5401095360	370+370
		4500	IPSS5401095450	
		5000	IPSS5401095500	

07 IPS 55x40

Gh	A	H	Kods	Integrācija Gh plaukti
		2200	IPSS5401100220	
		2600	IPSS5401100260	
		3000	IPSS5401100300	
1150	487	3600	IPSS5401100360	470+470
		4500	IPSS5401100450	
		5000	IPSS5401100500	

Gh	A	H	Kods	Integrācija Gh plaukti
		2200	IPSS5401105220	
		2600	IPSS5401105260	
		3000	IPSS5401105300	
1350	587	3600	IPSS5401105360	570+570
		4500	IPSS5401105450	
		5000	IPSS5401105500	

Gh	A	H	Kods	Integrācija Gh plaukti
		2200	IPSS5401115220	
		2600	IPSS5401115260	
		3000	IPSS5401115300	
1550	687	3600	IPSS5401115360	670+670
		4500	IPSS5401115450	
		5000	IPSS5401115500	

01.09 Vidējie rāmji divpusējai integrācijai

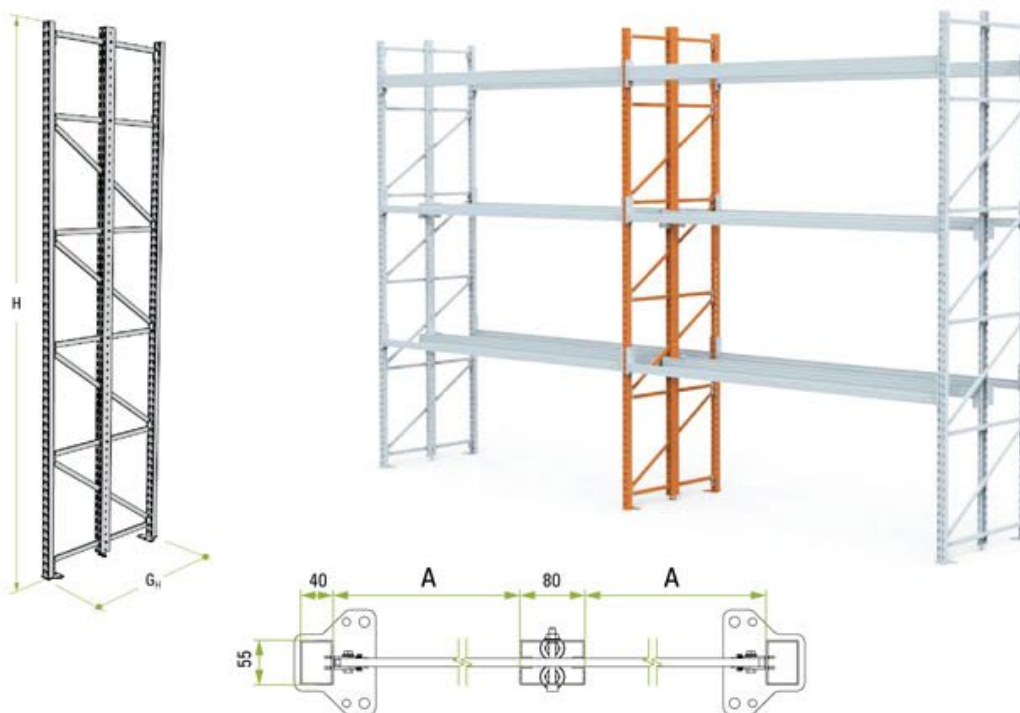

Gh	A	H	Kods	Integrācija Gh plaukti
		2200	IPSS5401120220	
		2600	IPSS5401120260	
		3000	IPSS5401120300	
950	387	3600	IPSS5401120360	370+370
		4500	IPSS5401120450	
		5000	IPSS5401120500	

Gh	A	H	Kods	Integrācija Gh plaukti
		2200	IPSS5401130220	
		2600	IPSS5401130260	
		3000	IPSS5401130300	
1350	587	3600	IPSS5401130360	570+570
		4500	IPSS5401130450	
		5000	IPSS5401130500	

Gh	A	H	Kods	Integrācija Gh plaukti
		2200	IPSS5401125220	
		2600	IPSS5401125260	
		3000	IPSS5401125300	
1150	487	3600	IPSS5401125360	470+470
		4500	IPSS5401125450	
		5000	IPSS5401125500	

Gh	A	H	Kods	Integrācija Gh plaukti
		2200	IPSS5401135220	
		2600	IPSS5401135260	
		3000	IPSS5401135300	
1550	687	3600	IPSS5401135360	670+670
		4500	IPSS5401135450	
		5000	IPSS5401135500	



Sijas (traversas) ir galvenie horizontālie elementi, kas veido plauktu IPS pamata nesējkonstrukcijas struktūru.

Sijas (traversas) konstruktīvi ir veidotas no dažādu veidu tērauda profiliem, ar galos piemetinātām atbilstoši veidotām ķepām, kas nodrošina pareizu nostiprināšanu rāmju statņu perforācijā.

Piedāvājam plašu siju (traversu) klāstu, kas ļauj precīzi piemeklēt plaukta konstrukcijas individuālajām vajadzībām.

Zemāk uzrādīta visvairāk izmantoto traversu šķērsriezuma izvēle, ar tām piemērotām ķepām, kas sametinātas sekojošās pozīcijās:

Apakšējā, augšējā un vidējā (standarts).

	IPS 140R4	IPS 120R4	IPS 100R4	IPS 080S4	IPS 060S4	IPS 060M4	IPS 080M4	IPS 100M4
Traversas augšējās								
Traversas vidējās								
Traversas apakšējās								

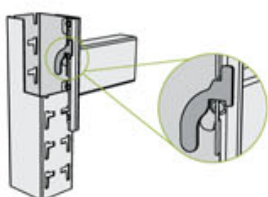

Katra traversa pēc montāžas rāmja perforācijā ir jānodrošina pret izkrišanu, ar sijas fiksatoru.

09 IPS 55x40

Tabula nr. 3. Tabula, kurā parādīta traversu pieļaujamā slodze centrālajai traversas sijas metināšanas pozīcijai pie ķepas.

	IPS 060M4 (60x40x2,0) S235	IPS 080M4 (80x40x2,0) S235	IPS 060S4 (6x40x2,5) S235	IPS 080S4 (80x40x2,0) S235	IPS 100R4 (100x40x2,0) S355	IPS 120R4 (120x40x2,0) S355	IPS 140R4 (140x40x2,0) S355
1250	1050	1550	1600	1880	3800	5000	5000
1330	1000	1500	1500	1800	3600	4700	5000
2000	720	1030	1050	1250	2500	3200	3900
2500	620	880	850	1050	2000	2600	3200
2660	590	850	780	1000	1800	2450	3050
2730	550	820	750	950	1750	2400	3000
3000	450	750	650	900	1450	2150	2750

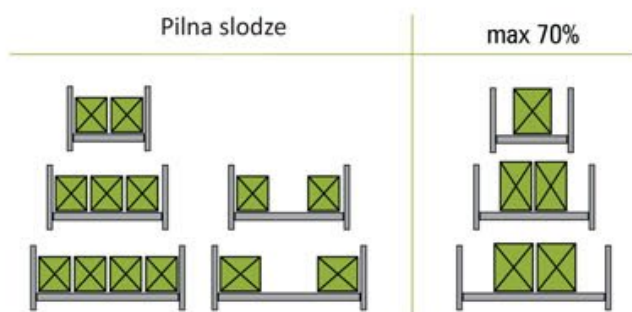

3.un 4. tabulā uzrādītās pieļaujamās slodzes traversu pāriem (ligzdām) ir pareizas atbilstoši izvietotai slodzei (pilnai slodzei).

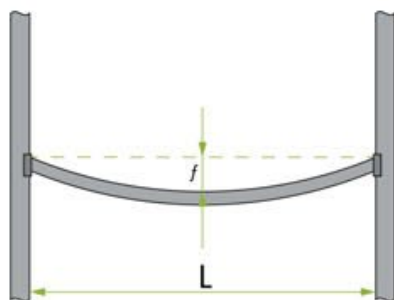

Pareizi noslogotām traversām f izliekums nedrīkst būt lielāks par $1/200L$.

02.01 Traversa IPS 060S4

Augšējais tips



Vidējais tips



Apakšējais tips

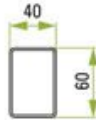

UZMANĪBU:

Katrai traversai ir jāpasūta divi fiksatori: IPS55401230

Lh [mm]	Augšējais	Vidējais	Apakšējais
1250	IPS55401145	IPS55401146	IPS55401147
1330	IPS55401148	IPS55401149	IPS55401150
2000	IPS55401151	IPS55401152	IPS55401153
2500	IPS55401154	IPS55401155	IPS55401156
2660	IPS55401157	IPS55401158	IPS55401159
2730	IPS55401160	IPS55401161	IPS55401162
3000	IPS55401163	IPS55401164	IPS55401165

02.02 Traversa IPS 080S4

Augšējais tips



Vidējais tips

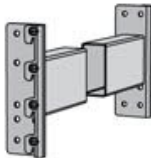

Apakšējais tips

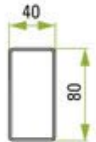

UZMANĪBU:

Katrai traversai ir jāpasūta divi fiksatori: IPS55401230

Lh [mm]	Augšējais	Vidējais	Apakšējais
1250	IPS55401166	IPS55401167	IPS55401168
1330	IPS55401169	IPS55401170	IPS55401171
2000	IPS55401172	IPS55401173	IPS55401174
2500	IPS55401175	IPS55401176	IPS55401177
2660	IPS55401178	IPS55401179	IPS55401180
2730	IPS55401181	IPS55401182	IPS55401183
3000	IPS55401184	IPS55401185	IPS55401186

02.03 Traversa IPS 100R4

Augšējais tips



Vidējais tips



Apakšējais tips

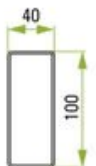

UZMANĪBU:

Katrai traversai ir jāpasūta divi fiksatori: IPS55401230

Lh [mm]	Augšējais	Vidējais	Apakšējais
1250	IPS55401187	IPS55401188	IPS55401190
1330	IPS55401191	IPS55401192	IPS55401193
2000	IPS55401194	IPS55401195	IPS55401196
2500	IPS55401197	IPS55401198	IPS55401199
2660	IPS55401200	IPS55401201	IPS55401202
2730	IPS55401203	IPS55401204	IPS55401205
3000	IPS55401206	IPS55401207	IPS55401208

02.04 Traversa IPS 120R4

Augšējais tips



Vidējais tips



Apakšējais tips

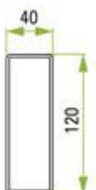
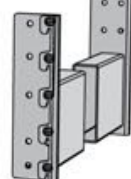

UZMANĪBU:

Katrai traversai ir jāpasūta divi fiksatori: IPS55401230

Lh [mm]	Augšējais	Vidējais	Apakšējais
1250	IPS55401209	IPS55401210	IPS55401211
1330	IPS55401212	IPS55401213	IPS55401214
2000	IPS55401215	IPS55401216	IPS55401217
2500	IPS55401218	IPS55401219	IPS55401220
2660	IPS55401221	IPS55401222	IPS55401223
2730	IPS55401224	IPS55401225	IPS55401226
3000	IPS55401227	IPS55401228	IPS55401229

11 IPS 55x40

02.05 Traversa IPS 140R4

Augšējais tips



Vidējais tips



Apakšējais tips

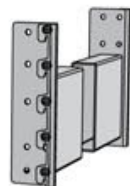

Lh [mm]	Augšējais	Vidējais	Apakšējais
1250	IPS55401231	IPS55401232	IPS55401233
1330	IPS55401234	IPS55401235	IPS55401236
2000	IPS55401237	IPS55401238	IPS55401239
2500	IPS55401240	IPS55401241	IPS55401242
2660	IPS55401243	IPS55401244	IPS55401245
2730	IPS55401246	IPS55401247	IPS55401248
3000	IPS55401249	IPS55401250	IPS55401251



UZMANĪBU:

Katrai traversai ir jāpasūta divi fiksatori: IPS55401230

02.06 Trepju traversa IPS 060M4

Augšējais tips

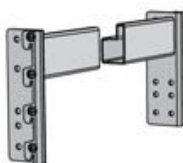

Vidējais tips



Apakšējais tips

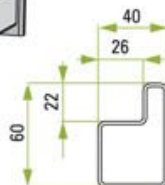

Lh [mm]	Augšējais	Vidējais	Apakšējais
1250	IPS55401252	IPS55401253	IPS55401254
1330	IPS55401255	IPS55401256	IPS55401257
2000	IPS55401258	IPS55401259	IPS55401260
2500	IPS55401261	IPS55401262	IPS55401263
2660	IPS55401264	IPS55401265	IPS55401266
2730	IPS55401267	IPS55401268	IPS55401269
3000	IPS55401270	IPS55401271	IPS55401272



UZMANĪBU:

Katrai traversai ir jāpasūta divi fiksatori: IPS55401230

02.07 Trepju traversa IPS 080M4

Augšējais tips

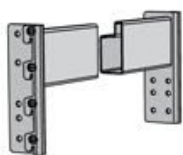

Vidējais tips

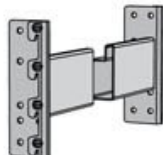

Apakšējais tips

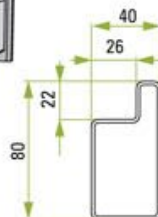
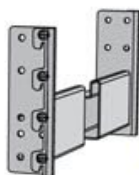

Lh [mm]	Augšējais	Vidējais	Apakšējais
1250	IPS55401273	IPS55401274	IPS55401275
1330	IPS55401276	IPS55401277	IPS55401278
2000	IPS55401279	IPS55401280	IPS55401281
2500	IPS55401282	IPS55401283	IPS55401284
2660	IPS55401285	IPS55401286	IPS55401287
2730	IPS55401288	IPS55401289	IPS55401290
3000	IPS55401291	IPS55401292	IPS55401293



UZMANĪBU:

Katrai traversai ir jāpasūta divi fiksatori: IPS55401230

02.08 Trepju traversa IPS 100M4

Augšējais tips

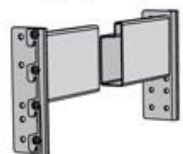

Vidējais tips

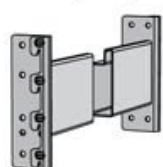

Apakšējais tips

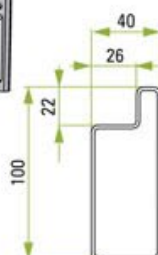
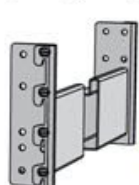

Lh [mm]	Augšējais	Vidējais	Apakšējais
1250	IPS55401294	IPS55401295	IPS55401296
1330	IPS55401297	IPS55401298	IPS55401299
2000	IPS55401300	IPS55401301	IPS55401302
2500	IPS55401303	IPS55401304	IPS55401305
2660	IPS55401306	IPS55401307	IPS55401308
2730	IPS55401309	IPS55401310	IPS55401311
3000	IPS55401312	IPS55401313	IPS55401314



UZMANĪBU:

Katrai traversai ir jāpasūta divi fiksatori: IPS55401230

02.09 Speciālā traversa IPS 060S4

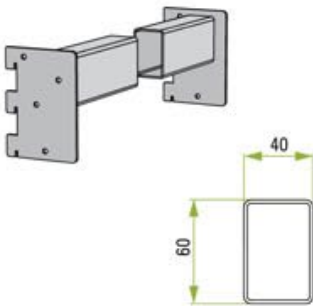

Lh [mm]	Kods
1250	IPS55401315
1330	IPS55401316
2000	IPS55401317
2500	IPS55401318
2660	IPS55401319
2730	IPS55401320
3000	IPS55401321

UZMANĪBU:
Katrai traverai ir jāpasūta divi fiksatori: IPS55401230

02.10 Speciālā traversa IPS 060M4

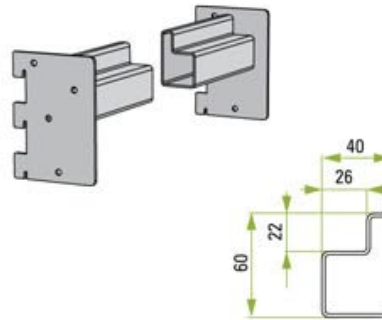

Lh [mm]	Kods
1250	IPS55401322
1330	IPS55401323
2000	IPS55401324
2500	IPS55401325
2660	IPS55401326
2730	IPS55401327
3000	IPS55401328

UZMANĪBU:
Katrai traverai ir jāpasūta divi fiksatori: IPS55401230

02.11 Noņemtā traversa IPS 060S4

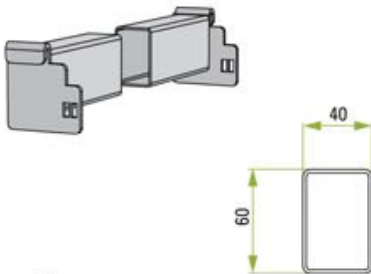

Lh [mm]	Kods
1250	IPS55401329
1330	IPS55401330
2000	IPS55401331
2500	IPS55401332
2660	IPS55401333
2730	IPS55401334
3000	IPS55401335

UZMANĪBU:
Katrai traverai ir jāpasūta divi fiksatori: IPS55401351

02.12 Speciāla trepju traversa IPS 060M4

(izmantošanai kopā ar kronšteinu IPS5540...; IPS5540... ;
Pārī ar traverām [02.11.] IPS 060M4)

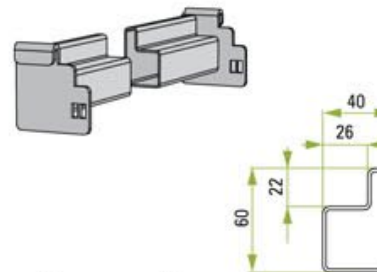

Lh [mm]	Kods
1250	IPS55401336
1330	IPS55401337
2000	IPS55401338
2500	IPS55401339
2660	IPS55401340
2730	IPS55401341
3000	IPS55401342

UZMANĪBU:
Katrai traverai ir jāpasūta divi fiksatori: IPS55401351

02.13 Speciālo traveru kronšteinu [02.11.] vai [02.12.]

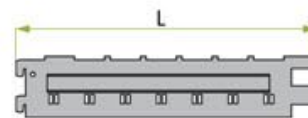
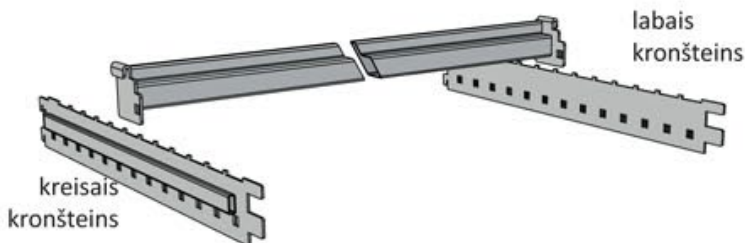

Kronšteins (kreisais)	Rāmis (G)	L	Kronšteins (labais)
IPS55401343	950	420	IPS55401347
IPS55401344	1150	520	IPS55401348
IPS55401345	1350	620	IPS55401349
IPS55401346	1550	720	IPS55401350

13 IPS 55x40

Siju pārlikas 27x40 paletēm



03.01 Siju pārlika 27x40 traversām 40 mm



Rāmis		Siju pārlika	
Tips	Gh	G	Kods
	600	474	IPS55401352
	700	574	IPS55401353
	800	674	IPS55401354
Mini 55x40	950	841	IPS55401355
	1150	1041	IPS55401356
	1350	1241	IPS55401357
	1550	1441	IPS55401358

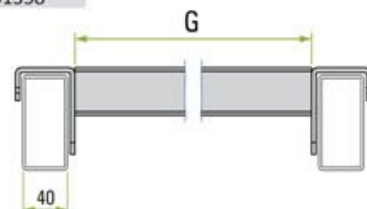
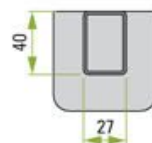

03.02 Siju pārlika 50x40 traversām 40 mm



Rāmis		Siju pārlika	
Tips	Gh	G	Kods
	600	474	IPS55401359
	700	574	IPS55401360
	800	674	IPS55401361
Mini 55x40	950	841	IPS55401362
	1150	1041	IPS55401363
	1350	1241	IPS55401364
	1550	1441	IPS55401365

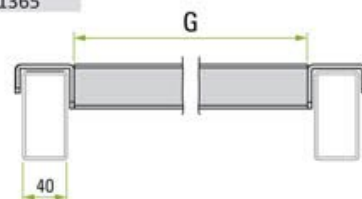



03.03 Siju pārlika 27x40 traversām 40 mm



Rāmis		Siju pārlika	
Tips	Gh	G	Kods
	600	474	IPS55401366
	700	574	IPS55401367
	800	674	IPS55401368
Mini 55x40	950	841	IPS55401369
	1150	1041	IPS55401370
	1350	1241	IPS55401371
	1550	1441	IPS55401372

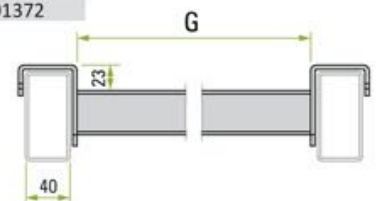
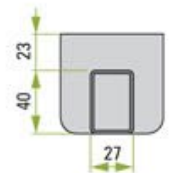

03.04 Siju pārlika 50x40 traversām 40 mm



Rāmis		Siju pārlika	
Tips	Gh	G	Kods
	600	474	IPS55401373
	700	574	IPS55401374
	800	674	IPS55401375
Mini 55x40	950	841	IPS55401376
	1150	1041	IPS55401377
	1350	1241	IPS55401378
	1550	1441	IPS55401379

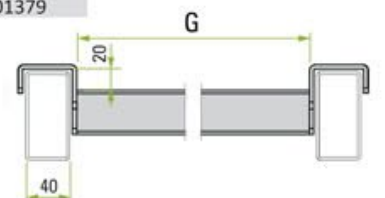
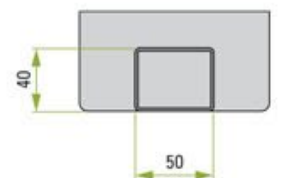

15 IPS 55x40

U-profila siju pārlīka



03.05 U-profila siju pārlīka

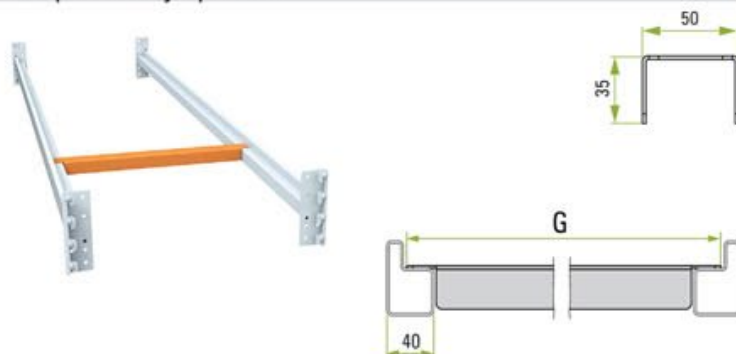

Rāmis		Siju pārlīka	
Tips	Gh	G	Kods
	600	533	IPSS5401380
	700	633	IPSS5401381
	800	733	IPSS5401382
Mini 55x40	900	833	IPSS5401383
	950	900	IPSS5401384
	1150	1100	IPSS5401385
	1350	1300	IPSS5401386

Plaukti



IPS sistēmas noliktavu aprīkojumā 80x70 mm un 55x40mm piedāvājam plašu plauktu izvēli, kas dos iespēju brīvi kombinēt atsevišķus plauktus. Plauktu klāstā atradīsiet sekojošus plauktu veidus:

- grīdas no plāksnēm,
- pilnie paneļu plaukti uz traversām 40mm un 50mm,
- perforēti paneļu plaukti uz traversām 40mm un 50mm,
- restoti plaukti (ugunsdroši) uz traversām 40mm un 50mm.

Mūsu piedāvātie paneļu, perforētie vai restotie plaukti var būt nokrāsoti Jūsu izvēlētajā krāsā ar pulverkrāsošanas metodi vai cinkoti.

Paneļu un perforēto paneļa plaukti ir platumā 186mm un 217mm, kas ļauj pielāgot atbilstošu plauktu komplektu atsevišķiem plauktu sekciju garumiem. Atkarībā no izvēlētajā modeļa plaukti var būt novietoti uz pilna profila traversām, saliekamām un trepju traversām.



Informācija par atsevišķu elementu slodzes izturību, kā arī plauktu veidi un kodi atrodami sadaļā "PLAUKTI".

IPS 55x40 16

Plaukti

04.01 IPS 80x70. Laminētu plākšņu plaukti izmantošanai plauktu sistēmās, kas aprīkotas ar 40mm platām traversām

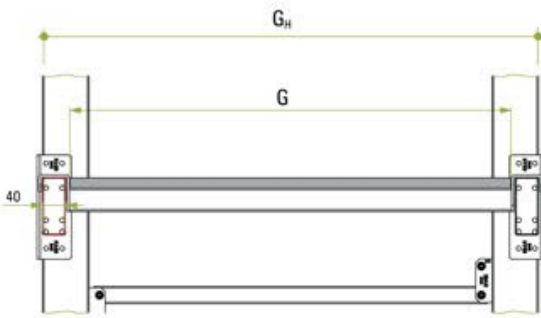

Rāmis Gh	Sija G	Plaukti	Traversa						
			1250	1330	2000	2500	2660	2730	3000
600	474	Izmēri	470x1200	470x1280	470x1950	470x2450	470x2615	470x2685	470x1475
		Kods	IPS55401387	IPS55401388	IPS55401389	IPS55401390	IPS55401391	IPS55401392	IPS55401393 x2
700	574	Izmēri	570x1200	570x1280	570x1950	570x2450	570x2615	570x2685	570x1475
		Kods	IPS55401394	IPS55401395	IPS55401396	IPS55401397	IPS55401398	IPS55401399	IPS55401400 x2
800	674	Izmēri	670x1200	670x1280	670x1950	670x2450	670x2615	670x2685	670x1475
		Kods	IPS55401401	IPS55401402	IPS55401403	IPS55401404	IPS55401405	IPS55401406	IPS55401407 x2
950	841	Izmēri	837x1200	837x1280	837x1950	837x2450	837x2615	837x2685	837x1475
		Kods	IPS55401408	IPS55401409	IPS55401410	IPS55401411	IPS55401412	IPS55401413	IPS55401414 x2
1150	1041	Izmēri	1037x1200	1037x1280	1037x1950	1037x2450	1037x2615	1037x2685	1037x1475
		Kods	IPS55401415	IPS55401416	IPS55401417	IPS55401418	IPS55401419	IPS55401420	IPS55401421 x2
1350	1241	Izmēri	1237x1200	1237x1280	1237x1950	1237x2450	1237x2615	1237x2685	1237x1475
		Kods	IPS55401422	IPS55401423	IPS55401424	IPS55401425	IPS55401426	IPS55401427	IPS55401428 x2
1550	1441	Izmēri	1437x1200	1437x1280	1437x1950	1437x2450	1437x2615	1437x2685	1437x1475
		Kods	IPS55401429	IPS55401430	IPS55401431	IPS55401432	IPS55401433	IPS55401434	IPS55401435 x2

04.02 IPS 80x70. Laminētu plākšņu plaukti izmantošanai plauktu sistēmās, kas aprīkotas ar trepju traversām

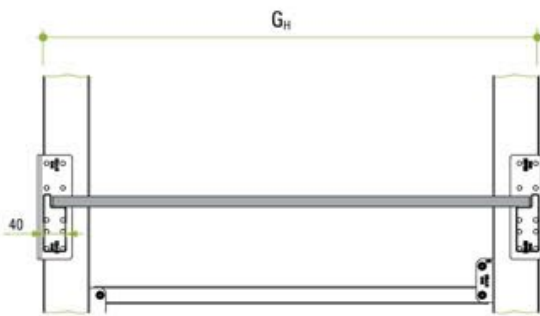

Rāmis Gh	Plaukti	Traversa						
		1250	1330	2000	2500	2660	2730	3000
600	Izmēri	535x1200	535x1280	535x1950	535x2450	535x2615	535x2685	535x1475
	Kods	IPS55401436	IPS55401437	IPS55401438	IPS55401439	IPS55401440	IPS55401441	IPS55401442 x2
700	Izmēri	635x1200	635x1280	635x1950	635x2450	635x2615	635x2685	635x1475
	Kods	IPS55401443	IPS55401444	IPS55401445	IPS55401446	IPS55401447	IPS55401448	IPS55401449 x2
800	Izmēri	735x1200	735x1280	735x1950	735x2450	735x2615	735x2685	735x1475
	Kods	IPS55401450	IPS55401451	IPS55401452	IPS55401453	IPS55401454	IPS55401455	IPS55401456 x2
950	Izmēri	902x1200	902x1280	902x1950	902x2450	902x2615	902x2685	902x1475
	Kods	IPS55401457	IPS55401458	IPS55401459	IPS55401460	IPS55401461	IPS55401462	IPS55401463 x2
1150	Izmēri	1102x1200	1102x1280	1102x1950	1102x2450	1102x2615	1102x2685	1102x1475
	Kods	IPS55401464	IPS55401465	IPS55401466	IPS55401467	IPS55401468	IPS55401469	IPS55401470 x2
1350	Izmēri	1302x1200	1302x1280	1302x1950	1302x2450	1302x2615	1302x2685	1302x1475
	Kods	IPS55401471	IPS55401472	IPS55401473	IPS55401474	IPS55401475	IPS55401476	IPS55401477 x2
1550	Izmēri	1502x1200	1502x1280	1502x1950	1502x2450	1502x2615	1502x2685	1502x1475
	Kods	IPS55401478	IPS55401479	IPS55401480	IPS55401481	IPS55401482	IPS55401483	IPS55401484 x2

17 IPS 55x40

Plaukti

04.03 Laminētu plākšņu plaukti izmantošanai divpusējās plauktu sistēmās, kas aprīkotas ar speciāla tipa trepju traversām IPS5540... [02.10.]

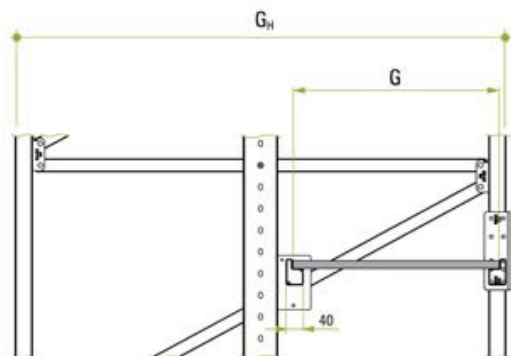

Rāmis G _H	Sija G	Plaukti	Traversa						
			1250	1330	2000	2500	2660	2730	3000
950	381	Izmēri	377x1200	377x1280	377x1950	377x2450	377x2615	377x2685	377x1475
		Kods	IPS55401485	IPS55401486	IPS55401487	IPS55401488	IPS55401489	IPS55401490	IPS55401491 x2
1150	481	Izmēri	477x1200	477x1280	477x1950	477x2450	477x2615	477x2685	477x1475
		Kods	IPS55401492	IPS55401493	IPS55401494	IPS55401495	IPS55401496	IPS55401497	IPS55401498 x2
1350	581	Izmēri	577x1200	577x1280	577x1950	577x2450	577x2615	577x2685	577x1475
		Kods	IPS55401499	IPS55401500	IPS55401501	IPS55401502	IPS55401503	IPS55401504	IPS55401505 x2
1550	681	Izmēri	677x1200	677x1280	677x1950	677x2450	677x2615	677x2685	677x1475
		Kods	IPS55401506	IPS55401507	IPS55401508	IPS55401509	IPS55401510	IPS55401511	IPS55401512 x2

04.04 Laminētu plākšņu plaukti izmantošanai plauktu sistēmās, kas aprīkotas ar speciāla tipa trepju traversām IPS5540... [02.12.]

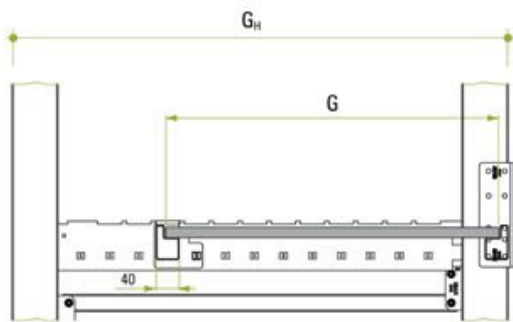

Rāmis G _H	A	Plaukti	Traversa						
			1250	1330	2000	2500	2660	2730	3000
600	377	Izmēri	377x1200	377x1280	377x1950	377x2450	377x2615	377x2685	377x1475
		Kods	IPS55401485	IPS55401486	IPS55401487	IPS55401488	IPS55401489	IPS55401490	IPS55401491 x2
700	377	Izmēri	377x1200	377x1280	377x1950	377x2450	377x2615	377x2685	377x1475
		Kods	IPS55401485	IPS55401486	IPS55401487	IPS55401488	IPS55401489	IPS55401490	IPS55401491 x2
700	477	Izmēri	477x1200	477x1280	477x1950	477x2450	477x2615	477x2685	477x1475
		Kods	IPS55401492	IPS55401493	IPS55401494	IPS55401495	IPS55401496	IPS55401497	IPS55401498 x2
800	377	Izmēri	377x1200	377x1280	377x1950	377x2450	377x2615	377x2685	377x1475
		Kods	IPS55401485	IPS55401486	IPS55401487	IPS55401488	IPS55401489	IPS55401490	IPS55401491 x2
800	477	Izmēri	477x1200	477x1280	477x1950	477x2450	477x2615	477x2685	477x1475
		Kods	IPS55401492	IPS55401493	IPS55401494	IPS55401495	IPS55401496	IPS55401497	IPS55401498 x2
800	577	Izmēri	577x1200	577x1280	577x1950	577x2450	577x2615	577x2685	577x1475
		Kods	IPS55401499	IPS55401500	IPS55401501	IPS55401502	IPS55401503	IPS55401504	IPS55401505 x2

Paneļu plaukti vienpusējai plauktu sistēmai



Trepju trersa IPS 060M4 [02.06.]

Augšējais tips

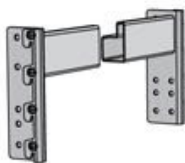

Vidējais tips

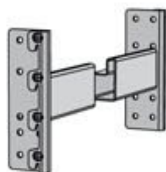

Apakšējais tips

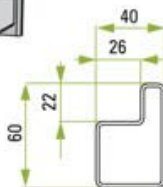
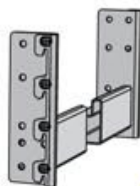

Lh [mm]	Augšējais	Vidējais	Apakšējais
1250	IPSS5401252	IPSS5401253	IPSS5401254
1330	IPSS5401255	IPSS5401256	IPSS5401257
2000	IPSS5401258	IPSS5401259	IPSS5401260
2500	IPSS5401261	IPSS5401262	IPSS5401263
2660	IPSS5401264	IPSS5401265	IPSS5401266
2730	IPSS5401267	IPSS5401268	IPSS5401269
3000	IPSS5401270	IPSS5401271	IPSS5401272



UZMANĪBU:

Katrai trersai ir jāpasūta divi fiksatori: IPSS5401230

04.05 Pilnie paneļa plaukti montējami vienpusējās plauktu sistēmās

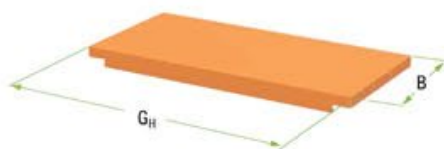

Tabulas izmantošana. Piemērs:

Lai saliktu plauktus plauktu sistēmā, kas uzbūvēta uz rāmja IPS 55x40 ar dziļumu G-1150mm, ar trersām L-2500 jāpasūta 5 paneļi IPSS540... un 7 paneļi IPSS540...

Rāmis		Plaukti		Trersa						
G _H	G _p	B	Kods	1250	1330	2000	2500	2660	2730	3000
600	536	186	IPSS5401513	4	1	1	5	-	12	3
		217	IPSS5401514	2	5	8	7	12	2	11
700	636	186	IPSS5401515	4	1	1	5	-	12	3
		217	IPSS5401516	2	5	8	7	12	2	11
700	477	186	IPSS5401517	4	1	1	5	-	12	3
		217	IPSS5401518	2	5	8	7	12	2	11

19 IPS 55x40

Plaukti

04.06 Perforētu paneļu plaukti montējami vienpusējās plauktu sistēmās

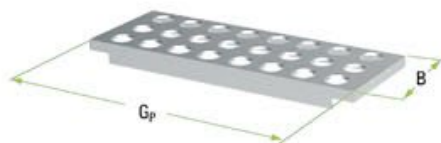

Tabulas izmantošana. Piemērs:

Lai saliktu plauktus plauktu sistēmā, kas uzbūvēta uz rāmja IPS 55x40 ar dziļumu G-1150mm, ar traversām L-2500 jāpasūta 5 paneļi IPS5540... un 7 paneļi IPS5540...

Rāmis		Plaukti		Traversa						
Gh	Gp	B	Kods	1250	1330	2000	2500	2660	2730	3000
600	536	186	IPS55401519	4	1	1	5	-	12	3
		217	IPS55401520	2	5	8	7	12	2	11
700	636	186	IPS55401521	4	1	1	5	-	12	3
		217	IPS55401522	2	5	8	7	12	2	11
700	477	186	IPS55401523	4	1	1	5	-	12	3
		217	IPS55401524	2	5	8	7	12	2	11

Pilno un perforēto paneļu plaukti, kas montējami divpusējās plauktu sistēmās



Speciālā traversa IPS 060M4 [02.10.]

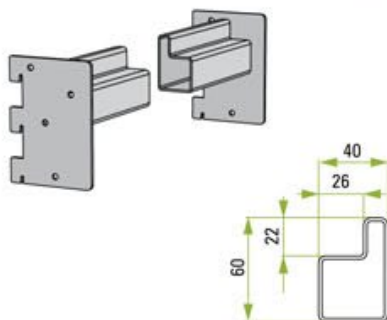

Lh [mm]	Kods
1250	IPS55401322
1330	IPS55401323
2000	IPS55401324
2500	IPS55401325
2660	IPS55401326
2730	IPS55401327
3000	IPS55401328

Treņu traversa IPS 060M4 [02.06.]

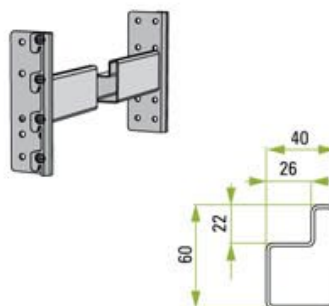

Lh [mm]	Kods
1250	IPS55401253
1330	IPS55401256
2000	IPS55401259
2500	IPS55401262
2660	IPS55401265
2730	IPS55401268
3000	IPS55401271

04.07 Pilnie paneļa plaukti, kas montējami divpusējās plauktu sistēmās



Tabulas izmantošana. Piemērs:

Lai saliktu plauktus plauktu sistēmā, kas uzbūvēta uz rāmja IPS 55x40 ar dziļumu G-1150mm, ar traversām L-2500 jāpasūta 5 paneli IP5540... un 7 paneli IP5540...

Rāmis	Panelis				Traversa							
	Gh	A	Gp	B	Kods	1250	1330	2000	2500	2660	2730	3000
950	387	377	186	186	IP55401525	4	1	1	5	-	12	3
			217	186	IP55401526	2	5	8	7	12	2	11
1150	487	477	186	186	IP55401527	4	1	1	5	-	12	3
			217	186	IP55401528	2	5	8	7	12	2	11
1350	587	577	186	186	IP55401529	4	1	1	5	-	12	3
			217	186	IP55401530	2	5	8	7	12	2	11
1550	687	677	186	186	IP55401531	4	1	1	5	-	12	3
			217	186	IP55401532	2	5	8	7	12	2	11

04.08 Perforēto paneļu plaukti, kas montējami divpusējās plauktu sistēmās

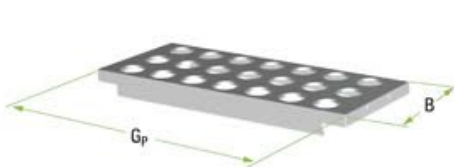

Tabulas izmantošana. Piemērs:

Lai saliktu plauktus plauktu sistēmā, kas uzbūvēta uz rāmja IPS 55x40 ar dziļumu G-1150mm, ar traversām L-2500 jāpasūta 5 paneli IP5540... un 7 paneli IP5540...

Rāmis	Panelis				Traversa							
	Gh	A	Gp	B	Kods	1250	1330	2000	2500	2660	2730	3000
950	387	377	186	186	IP55401533	4	1	1	5	-	12	3
			217	186	IP55401534	2	5	8	7	12	2	11
1150	487	477	186	186	IP55401535	4	1	1	5	-	12	3
			217	186	IP55401536	2	5	8	7	12	2	11
1350	587	577	186	186	IP55401537	4	1	1	5	-	12	3
			217	186	IP55401538	2	5	8	7	12	2	11
1550	687	677	186	186	IP55401539	4	1	1	5	-	12	3
			217	186	IP55401540	2	5	8	7	12	2	11

Pilno un perforēto paneļu plaukti izmantošanai plauktu sistēmās ar speciālām traversām, kas ļauj samazināt dziļumu



21 IPS 55x40

Plaukti

Speciāla trepju traversa IPS 060M4 [02.12.]

(izmantošanai kopā ar kronšteinu IPS5540...; IPS5540... ;
Pāri ar traversām [02.11.] IPS 060M4)

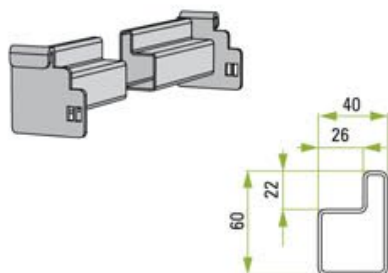

Lh [mm]	Kods
1250	IPS55401336
1330	IPS55401337
2000	IPS55401338
2500	IPS55401339
2660	IPS55401340
2730	IPS55401341
3000	IPS55401342



UZMANĪBU:

Katrai traversai ir jāpasūta divi fiksatori: IPS55401351

Kronšteini rāmjiem IPS 55x40 [02.13.]

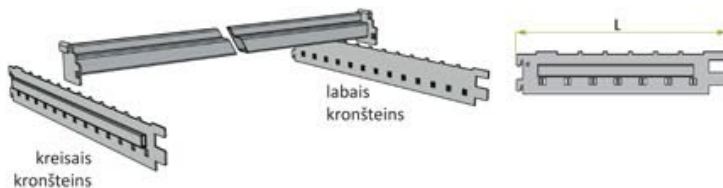

Kronšteins (kreisais)	Rāmis (G)	L	Kronšteins (labais)
IPS55401343	950	420	IPS55401347
IPS55401344	1150	520	IPS55401348
IPS55401345	1350	620	IPS55401349
IPS55401346	1550	720	IPS55401350

04.09 Pilnie paneļa plaukti

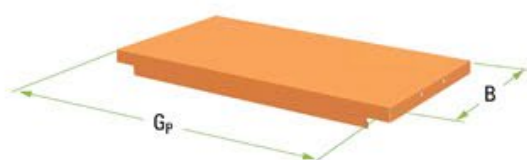

Tabulas izmantošana. Piemērs:

Lai dziļumu samazinātā plauktu sistēmā IPS 80x70 ar traversām L-2500 iebūvētu plauktu Gp-574 jāpasūta 5 paneļi IPS5540... un 7 paneļi IPS5540...

Rāmis		Plaukti		Traversa						
Gh	Gp	B	Kods	1250	1330	2000	2500	2660	2730	3000
600	377	186	IPS55401540	4	1	1	5	-	12	3
		217	IPS55401541	2	5	8	7	12	2	11
700	377	186	IPS55401542	4	1	1	5	-	12	3
		217	IPS55401543	2	5	8	7	12	2	11
800	477	186	IPS55401544	4	1	1	5	-	12	3
		217	IPS55401545	2	5	8	7	12	2	11

04.10 Perforēto paneļu plaukti

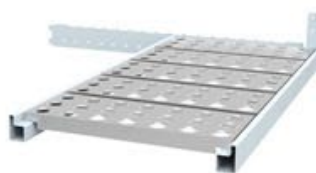
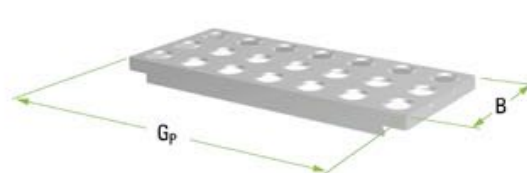

Tabulas izmantošana. Piemērs:

Lai dziļumu samazinātā plauktu sistēmā IPS 80x70 ar traversām L-2500 iebūvētu plauktu Gp-574 jāpasūta 5 paneļi IPS5540... un 7 paneļi IPS5540...

Rāmis		Plaukti		Traversa						
Gh	Gp	B	Kods	1250	1330	2000	2500	2660	2730	3000
600	536	186	IPS55401546	4	1	1	5	-	12	3
		217	IPS55401547	2	5	8	7	12	2	11
700	636	186	IPS55401548	4	1	1	5	-	12	3
		217	IPS55401549	2	5	8	7	12	2	11
700	477	186	IPS55401550	4	1	1	5	-	12	3
		217	IPS55401551	2	5	8	7	12	2	11

04.11 Plaukti no stieplu sieta vienaspusējās plauktu sistēmās

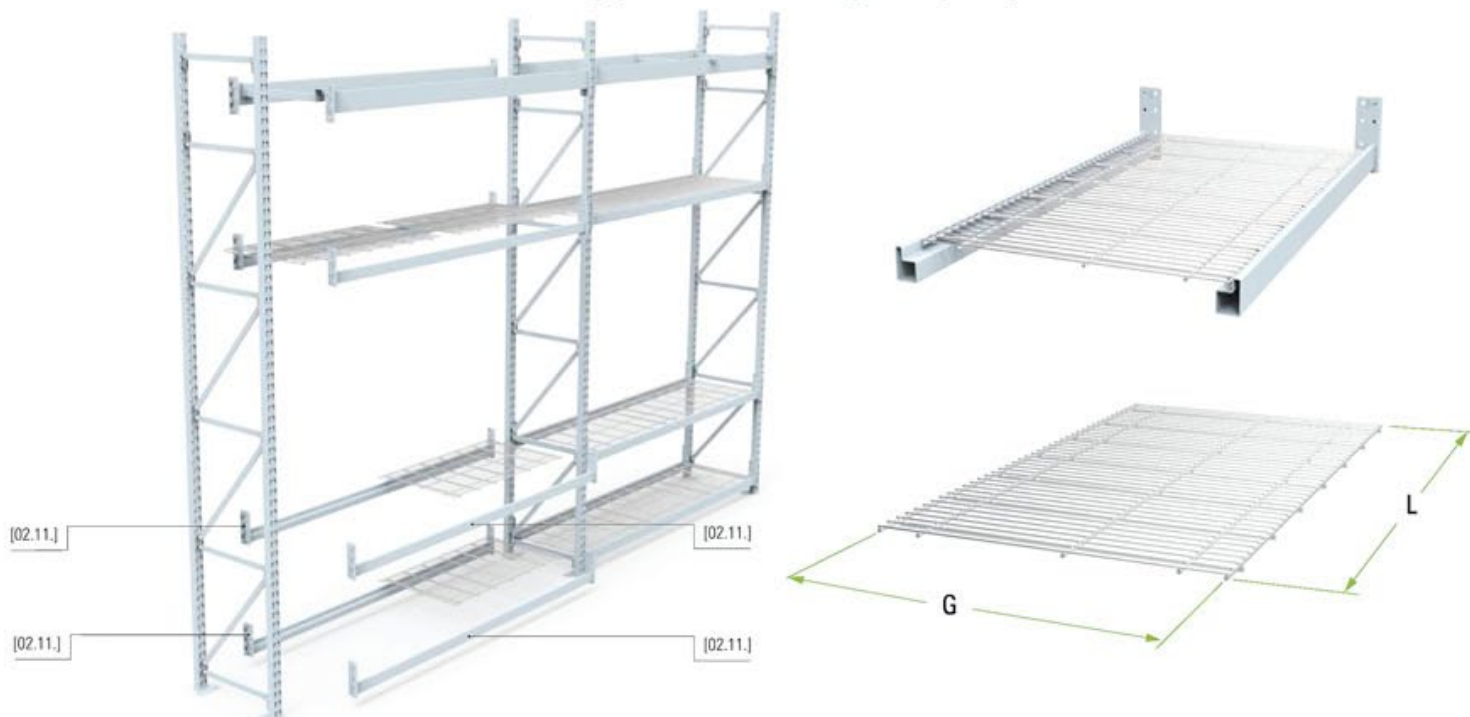

Stieplu plauktu izvēle izmantotajam rāmim un traversas garumam

Rāmis Gh	Stieplu plaukts	Traversas garums				
		1250	1330	2000	2500	2660
600	Izmēri GxL	536x1205	536x1288	536x975	536x1225	536x1308
	Kods	IPS55401552	IPS55401553	IPS55401554x2	IPS55401555x2	IPS55401556x2
700	Izmēri GxL	636x1205	636x1288	636x975	636x1225	636x1308
	Kods	IPS55401557	IPS55401558	IPS55401559x2	IPS55401560x2	IPS55401561x2
800	Izmēri GxL	736x1200	736x1280	736x1950	736x2450	736x2615
	Kods	IPS55401562	IPS55401563	IPS55401564x2	IPS55401565x2	IPS55401566x2

04.12 Plaukti no stieplu sieta divpusējās plauktu sistēmās

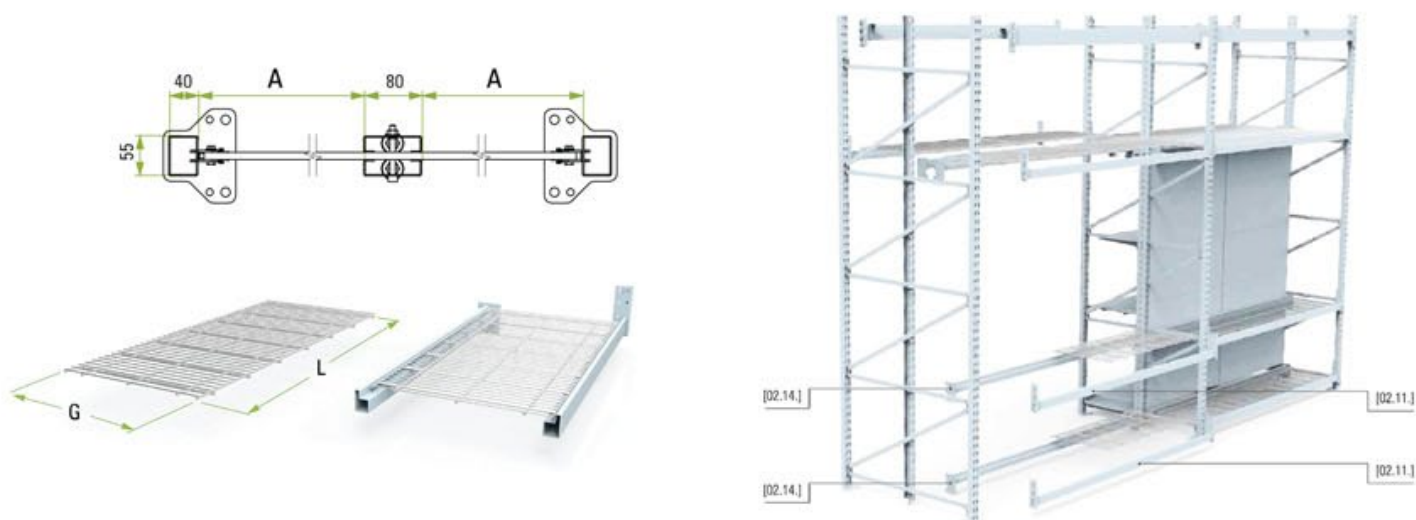

Stieplu plauktu izvēle izmantotajam rāmim un traversas garumam

Rāmis Gh	A	Stieplu plaukts	Traversas garums				
			1250	1330	2000	2500	2660
950	387	Izmēri GxL	377x1205	377x1288	377x975	377x1225	377x1308
		Kods	IPS55401567	IPS55401568	IPS55401569x2	IPS55401570x2	IPS55401571x2
1150	487	Izmēri GxL	477x1205	477x1288	477x975	477x1225	477x1308
		Kods	IPS55401572	IPS55401573	IPS55401574x2	IPS55401575x2	IPS55401576x2
1350	587	Izmēri GxL	577x1205	577x1288	577x975	577x1225	577x1308
		Kods	IPS55401577	IPS55401578	IPS55401579x2	IPS55401580x2	IPS55401581x2
1550	687	Izmēri GxL	677x1200	677x1280	677x1950	677x2450	677x2615
		Kods	IPS55401582	IPS55401583	IPS55401584x2	IPS55401585x2	IPS55401586x2

23 IPS 55x40

Tiešā integrācija ar veikala plauktu sistēmu



05.01 Centrālās kājas savienotājs 80x30 traversai 40mm

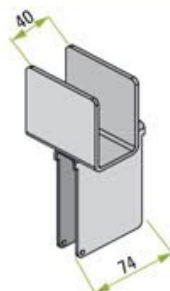

Kods
IPSS5401587



05.02 Kāja stabam 80x30mm



A
80

Kods
IPSS5401588

05.03 Pēda

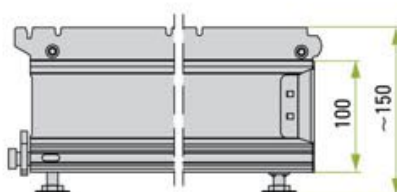
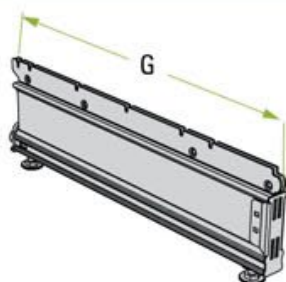

A	Kods
370	IPSS5401589
470	IPSS5401590
570	IPSS5401591
670	IPSS5401592
770	IPSS5401593

Vienpusēja integrācija ar veikala plauktu sistēmu

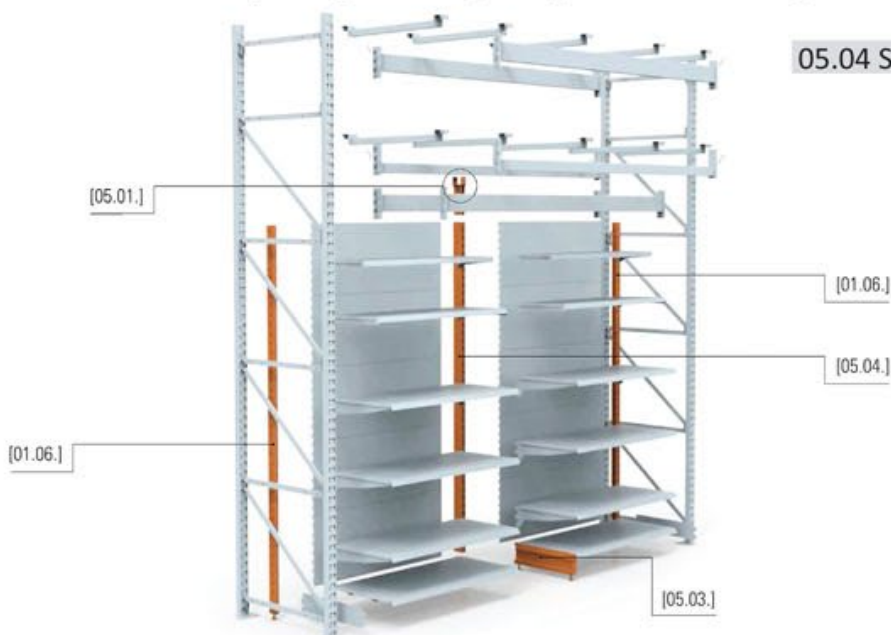

05.04 Statne plauktu sistēmai

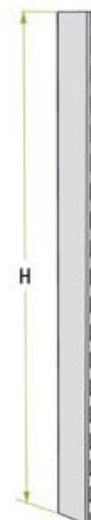
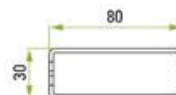
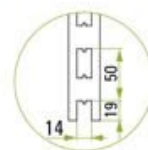

H	Statne (80x30)
2110	IPSS5401595211
2210	IPSS5401595221
2310	IPSS5401595231
2410	IPSS5401595241
2510	IPSS5401595251
2610	IPSS5401595261

Vienkāršais adapteris abpusējai integrācijai [01.06.]

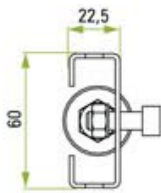
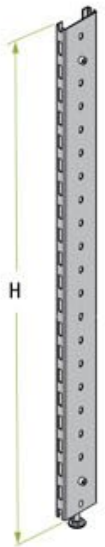

H [mm]	Profila kods
2200	IPSS5401075220
2300	IPSS5401075230
2500	IPSS5401075250
2600	IPSS5401075260
2900	IPSS5401075290
3000	IPSS5401075300
3500	IPSS5401075350
3600	IPSS5401075360
4000	IPSS5401075400
4500	IPSS5401075450
5000	IPSS5401075500

Abpusēja integrācija ar veikala plauktu sistēmu

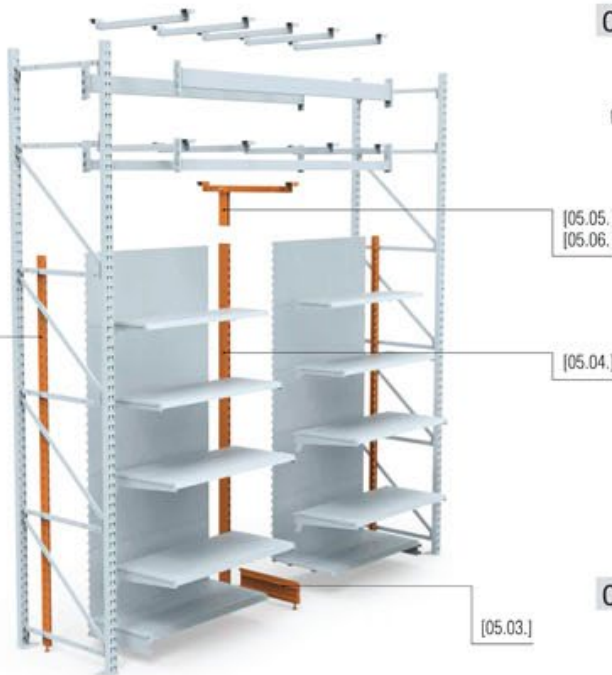

05.05 Siju pārlika 27x40 uz traversas 40 mm, integrācijai ar dziļuma samazināšanu

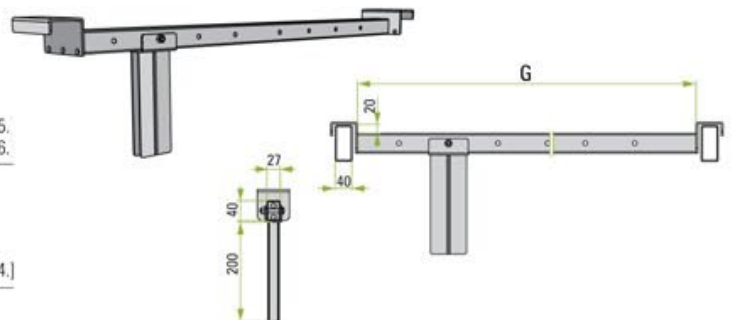

Tips	Rāmis		Siju pārlika	
	Gh	G	Kods	
IPS 55x40	700	574	IPSS5401600	
	800	674	IPSS5401601	

05.06 Siju pārlika 50x40 uz traversas 40 mm, integrācijai ar dziļuma samazināšanu

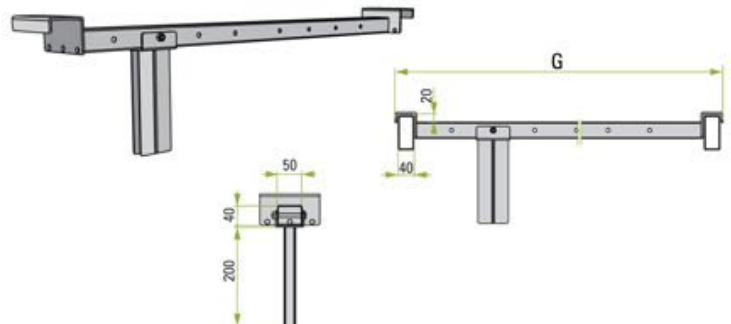

Tips	Rāmis		Siju pārlika	
	Gh	G	Kods	
IPS 55x40	700	574	IPSS5401602	
	800	674	IPSS5401603	

25 IPS 55x40

Siju pārlikas integrācijai

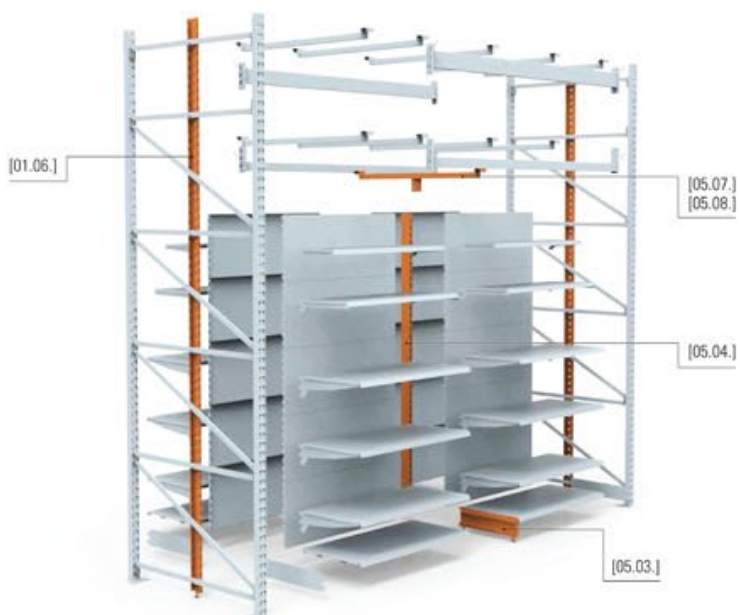

05.07 Siju pārlika

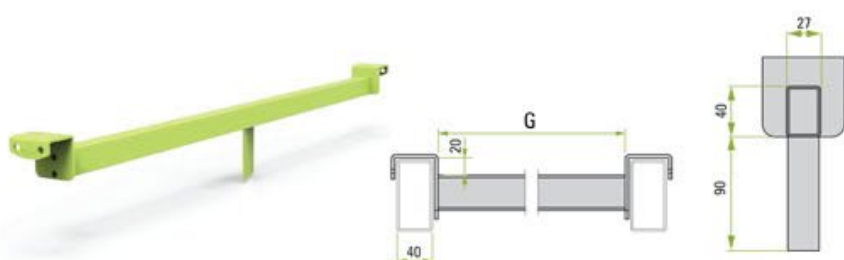

Tips	Rāmis		Siju pārlika	
	Gh	G	Kods	
IPS 55x40	950	841	IP555401604	
	1150	1041	IP555401605	
	1350	1241	IP555401606	
	1550	1441	IP555401607	

05.08 Siju pārlika

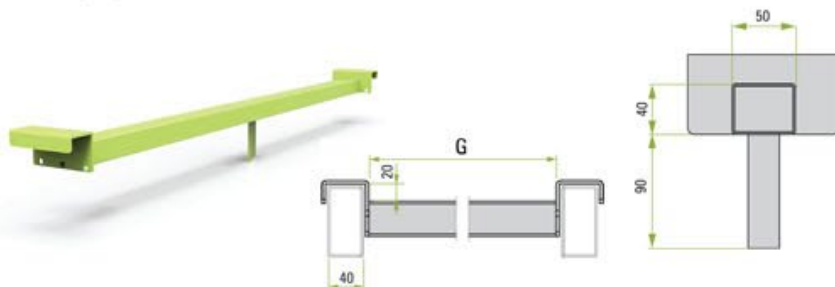

Tips	Rāmis		Siju pārlika	
	Gh	G	Kods	
IPS 55x40	950	841	IP555401608	
	1150	1041	IP555401609	
	1350	1241	IP555401610	
	1550	1441	IP555401611	

05.09 Aizmugures sienas paneļi

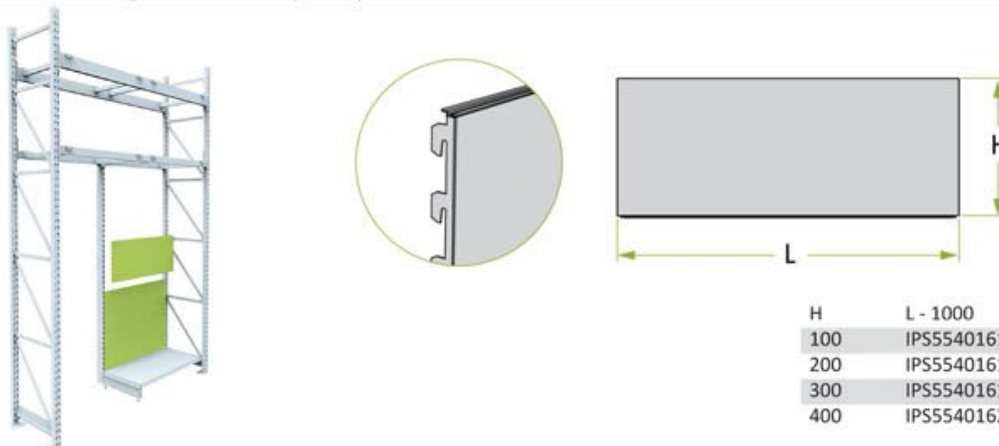

H	L - 1000	L - 1250	L - 1330
100	IP555401612	IP555401613	IP555401614
200	IP555401615	IP555401616	IP555401617
300	IP555401618	IP555401619	IP555401620
400	IP555401621	IP555401622	IP555401623

05.10 Aizmugures sienas paneli ar perforāciju "EURO"

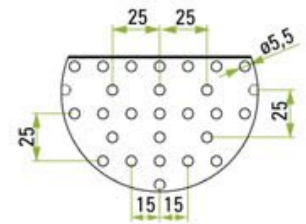
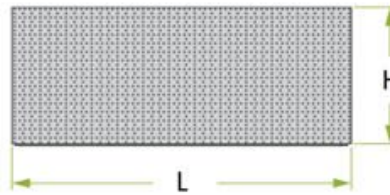

H	L - 1000	L - 1250	L - 1330
200	IPSS5401624	IPSS5401625	IPSS5401626
300	IPSS5401627	IPSS5401628	IPSS5401629
400	IPSS5401630	IPSS5401631	IPSS5401632

05.11 Aizmugures sienas paneli ar perforāciju "S"

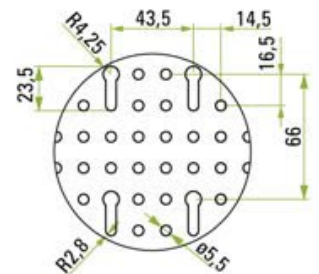
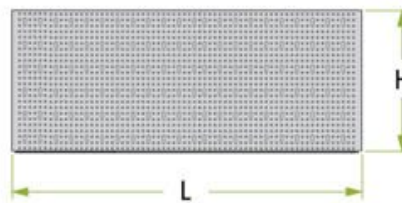
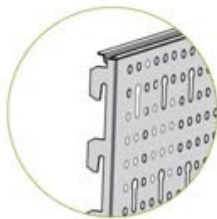

H	L - 1000	L - 1250	L - 1330
200	IPSS5401633	IPSS5401634	IPSS5401635
300	IPSS5401636	IPSS5401637	IPSS5401638
400	IPSS5401639	IPSS5401640	IPSS5401641

Plauktu balstu izvēle

Pareiza plauktu balstu izvēle plauktu sistēmai ar integrāciju nav viegls uzdevums. Daudzās iespējas, sarežģītās izmēru attiecības, ko izraisa atsevišķas prasības, veicina to, ka nepieciešama īpaša rūpība, izvēloties piemērotus plauktu balstus plauktu sistēmas konfigurācijai.

Lai ievērojami atvieglotu uzdevumu, 27.-28.lpp atradīsiet smalku plauktu balstu izmantošanas instrukciju, atkarībā no plauktu sistēmas izbūves koncepcijas palešu plauktā vai tā integrācijā.

05.12 Bāzes plauktu balsts



G - 370
IPSS5401642



G - 370÷470
IPSS5401643



G - 370÷570
IPSS5401644



G - 370÷670
IPSS5401645



G - 370÷770
IPSS5401646

27 IPS 55x40

05.13 Plauktu balsts

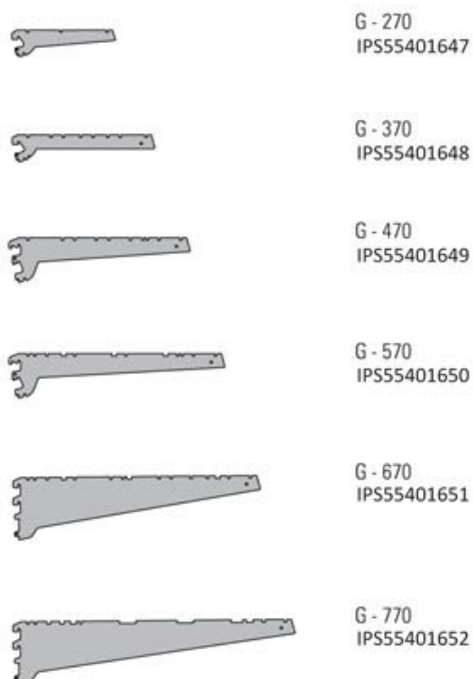

05.14 Plauktu balsts

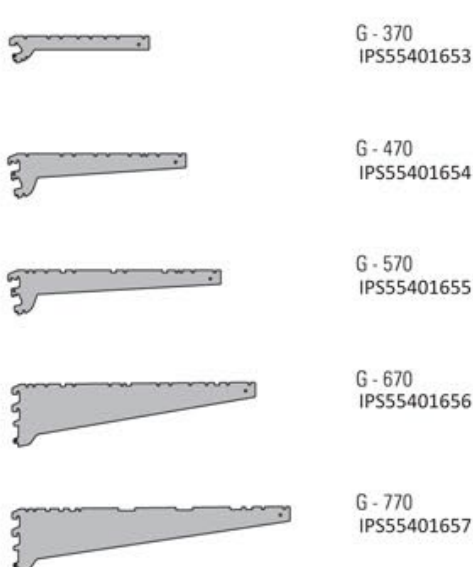

Integrācija ar maksimālo plauktu dziļumu G-370. Plauktu balstu piemērošana

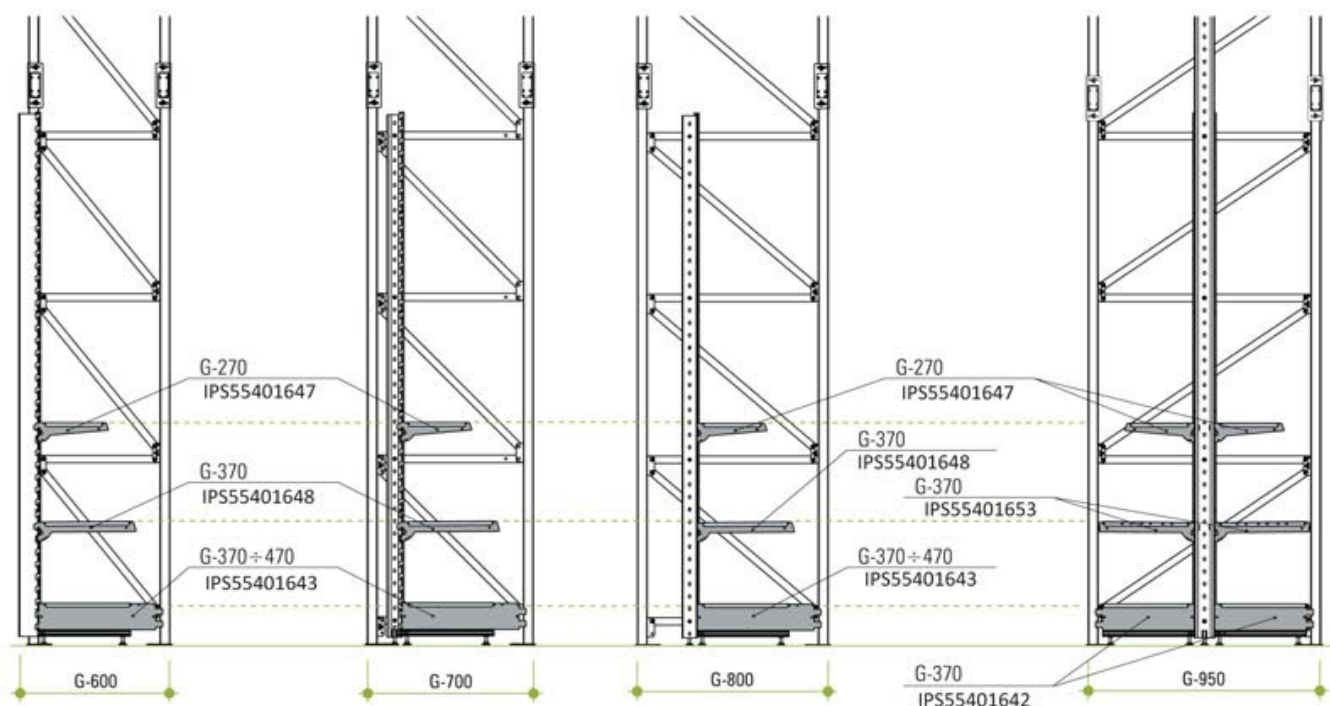

Integrācija ar maksimālo plauktu dziļumu G-470. Plauktu balstu piemērošana

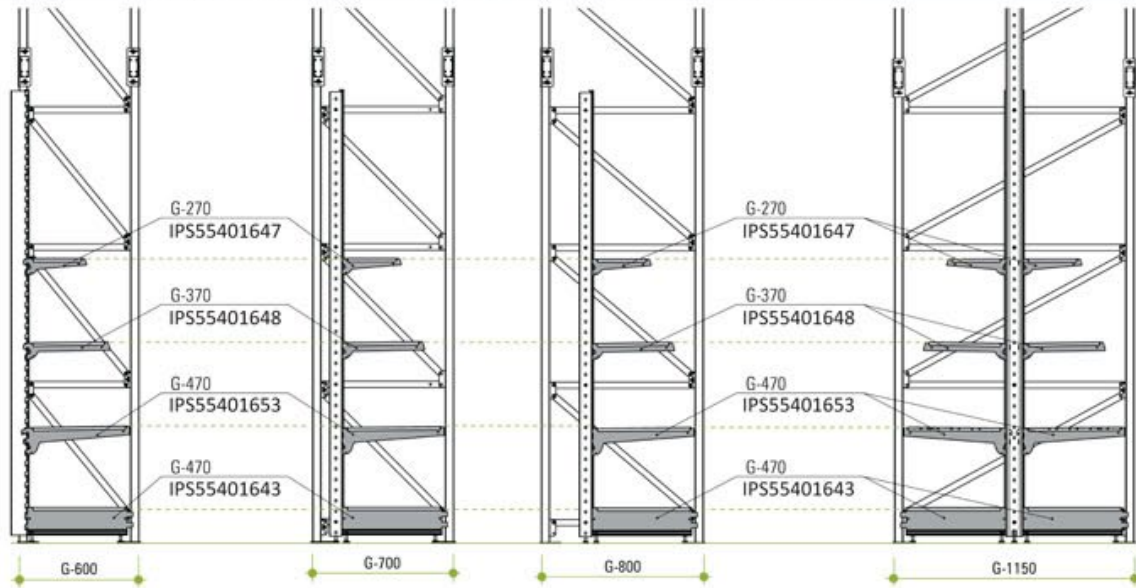

Integrācija ar maksimālo plauktu dziļumu G-570. Plauktu balstu piemērošana

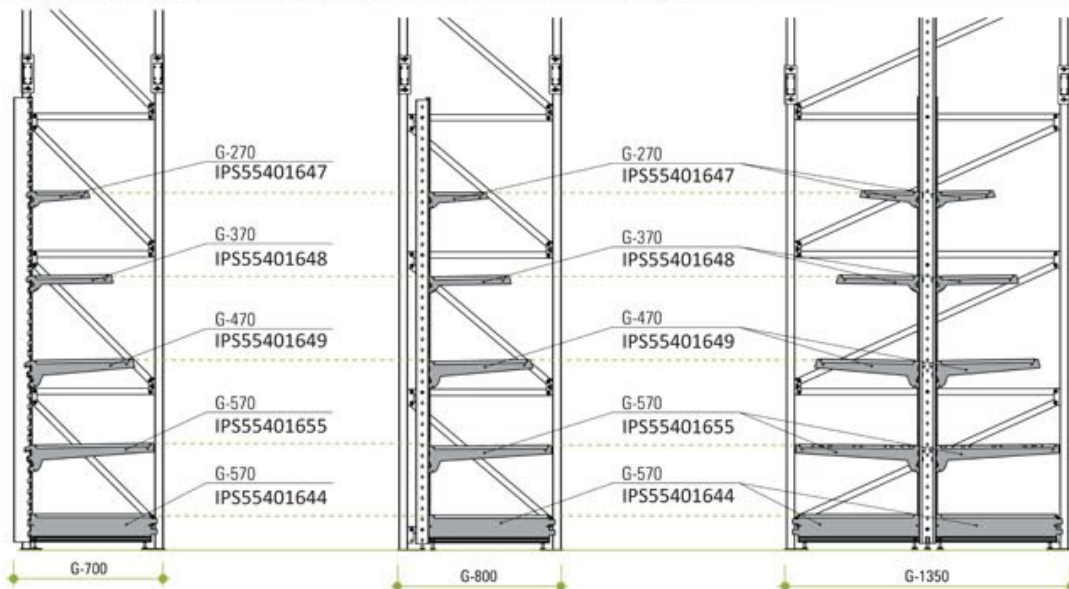

Integrācija ar maksimālo plauktu dziļumu G-670. Plauktu balstu piemērošana

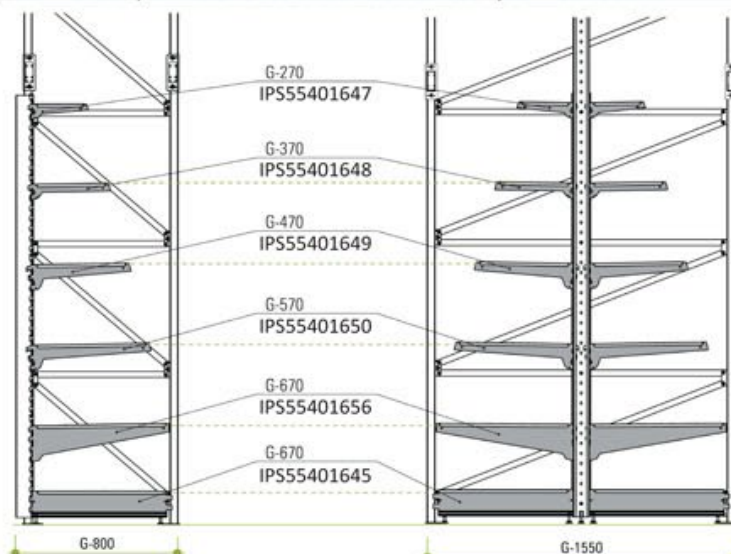

29 IPS 55x40

05.15 Plaukti

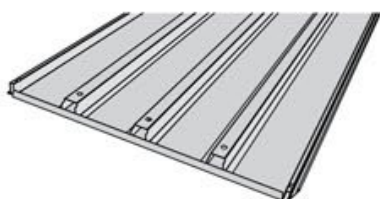
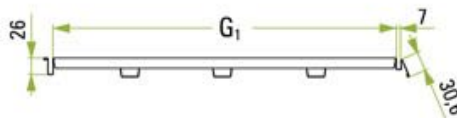
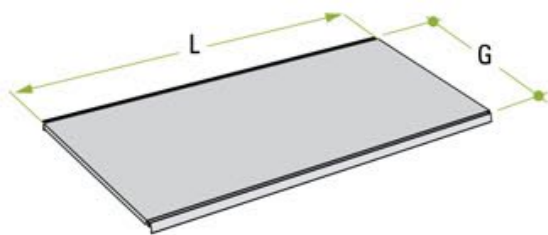

G	G1	L - 1000	L - 1250	L - 1330
270	232	IPS55401658	IPS55401659	IPS55401660
370	342	IPS55401661	IPS55401662	IPS55401663
470	442	IPS55401664	IPS55401665	IPS55401666
570	542	IPS55401667	IPS55401668	IPS55401669
670	642	IPS55401670	IPS55401671	IPS55401672
770	742	IPS55401673	IPS55401674	IPS55401675

05.16 Gala plaukti

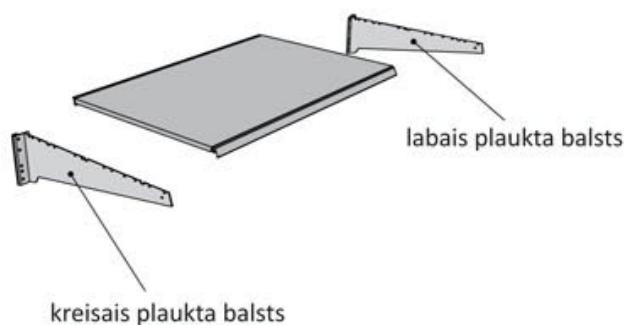

Rāmis Gh	G	Plaukti Kods	Plauktu balsti	
			Kreisais	Labais
950	470	IPS55401676	IPS55401685	IPS55401686
	570	IPS55401677	IPS55401687	IPS55401688
	670	IPS55401678	IPS55401689	IPS55401690
1150	470	IPS55401679	IPS55401685	IPS55401686
	570	IPS55401680	IPS55401687	IPS55401688
	670	IPS55401681	IPS55401689	IPS55401690
1350	470	IPS55401682	IPS55401685	IPS55401686
	570	IPS55401683	IPS55401687	IPS55401688
	670	IPS55401684	IPS55401689	IPS55401690

SIA "VISS VEIKALIEM UN NOLIKTAVĀM"

Kandavas iela 41A - 224 (kab), Rīga, LV-1083

tel. +371 27727449

tel. +371 20330002

www.vvn.lv

e-mail: info@vvn.lv

